



AMERICLAD® AC-110 Sunshade
www.americlad.com
866-260-4047

MANUFACTURER:
Quality Metalcrafts, LLC
21925 Industrial Blvd.
Rogers, MN 55374
Telephone: (866) 260-4047
Fax: (763) 255-3399
Email: info@americlad.com

**AMERICLAD
AC-110 Zee Blade
Sunshade**

SECTION 10 71 13 EXTERIOR SUN CONTROL DEVICES

PART 1 – GENERAL

1.1 RELATED DOCUMENTS

- A. The drawings and provisions of the General Conditions, and the sections included under Division 1 specification sections , apply to this section

1.2 SUMMARY

- A. This section includes horizontal and/or vertical aluminum sun control assemblies

1.3 PERFORMANCE REQUIREMENTS

- A. Structural performance: provide exterior sun control device assemblies capable of withstanding the effects of load and stresses from wind loads, dead loads, snow loads and normal and expected thermal movement without evidence of permanent defects of the assemblies. System design for a mechanically fastened assembly to substructure.
 - 1. Wind Load as required by applicable building code
 - 2. Dead Load as required by applicable building code
 - 3. Snow Load as required by applicable building code
 - 4. Snow Drift Load as required by applicable building code
- B. Design sun control device to eliminate vibration harmonics; wind whistles; and noises cause by thermal movement.

1.4 SUBMITTALS

- A. Product Data: Manufacturer's company literature



- B. Shop Drawings: Submit shop drawings showing layout, profiles and product components, including anchorage, accessories, finish.
- C. Structural Calculations: submit complete engineering calculations to support design.
- D. Finish Samples: submit color samples for final approval

1.5 QUALITY ASSURANCE

- A. Engineering Qualifications: Provide Engineering calculations for the sunshade system and mounting brackets, prepared by an engineer registered in the state the project is located
- B. Manufacturer Qualifications: Minimum of Five years experience in manufacturing of exterior sun control devices
- C. Installer Qualifications: Acceptable to manufacturer

1.6 DELIVERY, STORAGE AND HANDLING

- A. Delivery: deliver sun control devices in manufacturer's crates packaged for long haul transit
- B. Storage: store materials in a dry and safe area
- C. Handling: handle materials to avoid any damage to materials and finishes

1.7 WARRANTY

- A. The contractor must warrant the materials to be free of defects in accordance with the general conditions. Finish warranty shall be extended by paint manufacturer's standard warranty.

PART 2 – PRODUCTS

2.1 MANUFACTURER

- A. Quality Metalcrafts, LLC, 21925 Industrial Boulevard, Rogers, Minnesota 55374, Telephone (866) 260-4047, www.americlad.com
 - a. Americlad Exterior Sunshade Devices

2.2 MATERIALS

- A. Aluminum Sheet: ASTM B209, Alloy 6061-T6, 5005-H34 or 3003-H14
- B. Aluminum Extrusions: ASTM B221, Alloy 6063-T6 and/or 6061-T6

2.3 FABRICATION

- A. Factory assembled sun control devices for a turnkey installation
- B. Blades will be mechanically fastened with stainless steel screws to the outriggers. Spot welds only to be used where mechanical fastening of parts is prohibitive.



C. Maintain blade spacing per approved shop drawings

2.4 HORIZONTAL/VERTICAL SUN CONTROL DEVICES

- A. Outrigger: Specify outrigger profile and thickness
- B. Blade: Specify blade size from manufacturer's selection
- C. Fascia: Specify fascia profile and design

2.5 SUN CONTROL DESIGN

a. Series AC-110 (Zee)

2.6 FINISHES

- A. High Performance Coating: Organic coating: Clean and prime exposed aluminum surfaces and apply a Kynar 500 finish conforming to AAMA 2605, color to be determined by the architect
- B. Class I, Clear Anodic Finish: AA-M12C22A41, mechanical finish, nonspecular as fabricated. Coating to have an anodic coating of 0.7 mil (0.018 mm) thickness
- C. Class I, Color Anodic Finish: AA-M12C22A42/A44, mechanical finish, nonspecular as fabricated. Color to be determined by Architect. Coating to have an anodic coating of 0.7 mil (0.018 mm) thickness

PART 3 – EXECUTION

3.1 PREPARATION

- A. Coordinate drawings, diagrams, fixtures, instructions and instructions for installation of anchors to structure.

3.2 INSTALLATION

- A. Attach anchorage to structure per shop drawing
- B. Install sun control device units level and plumb

3.3 CLEANING AND PROTECTING

- A. Clean exposed surfaces after installation per manufacturers recommendations
- B. Touch up minor abrasions in finish with touch up paint supplied by finish applicator.

END OF SECTION



AC-110

EXTERIOR SUN CONTROL DEVICE (ZEE BLADES)

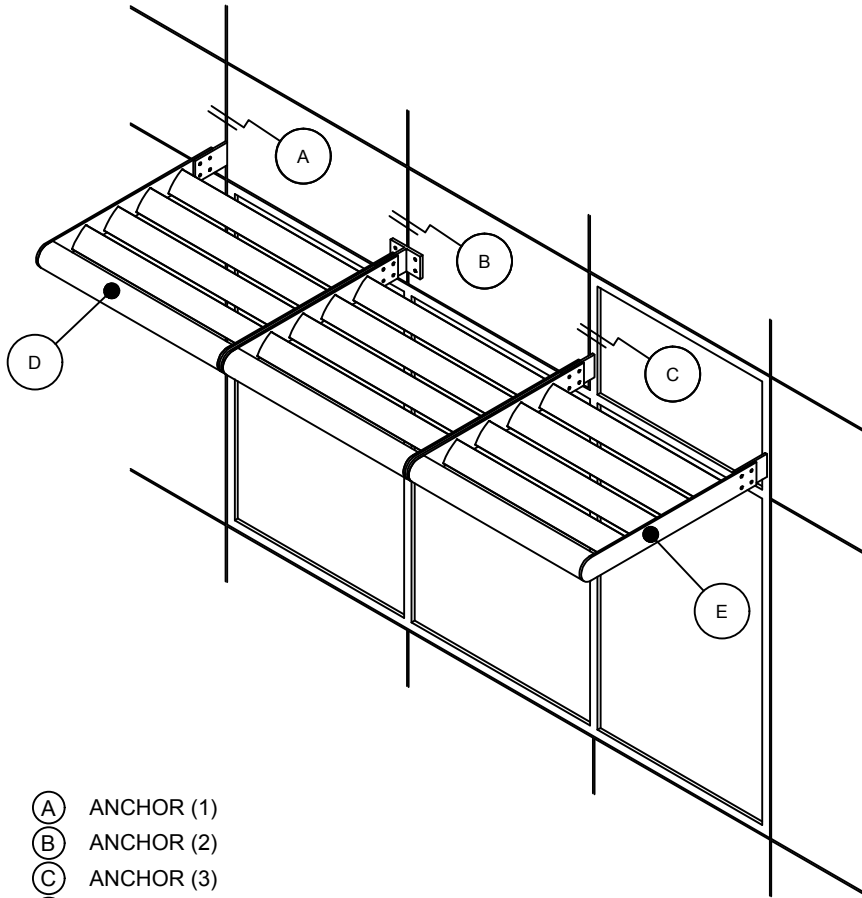

- (A) ANCHOR (1)
- (B) ANCHOR (2)
- (C) ANCHOR (3)
- (D) SUNSHADE COMPONENTS
- (E) OUTRIGGER PROFILES

COPYRIGHT QUALITY METALCRAFTS, LLC

21925 Industrial Boulevard · Rogers, Minnesota · Toll-Free: 1-866-260-4047 · americlad.com

Architectural Metal Products



AC-110

ANCHOR (1)

DETAIL A

NOTE:

LOAD BEARING WALL COMPONENTS OF EITHER: 16GA STEEL STUDS, STRUCTURAL MEMBERS, MINIMUM 5/8" PLYWOOD OR CONCRETE. GYPSUM BOARD AND CEMENT BOARD ARE NOT A STRUCTURAL COMPONENT.

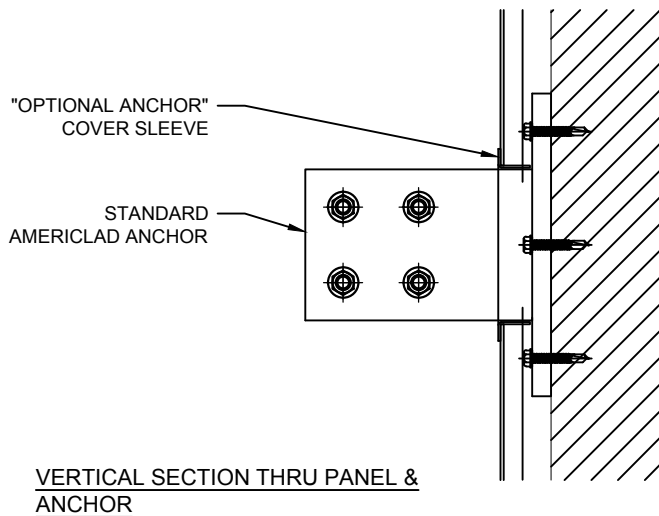
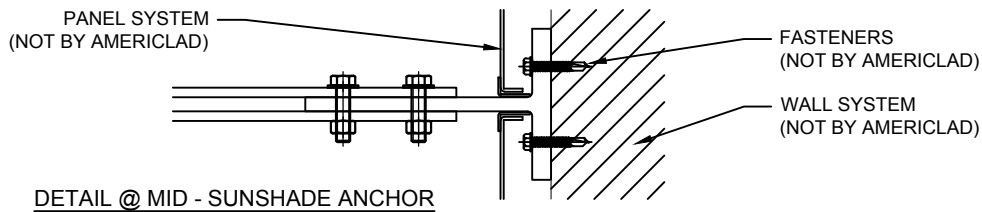
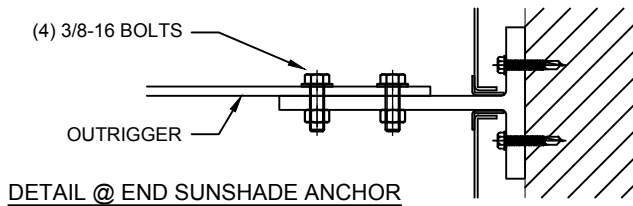

COPYRIGHT QUALITY METALCRAFTS, LLC

21925 Industrial Boulevard · Rogers, Minnesota · Toll-Free: 1-866-260-4047 · americlad.com

Architectural Metal Products



AC-110

ANCHOR (2)

DETAIL B

NOTE:

LOAD BEARING WALL COMPONENTS OF EITHER: 16GA STEEL STUDS, STRUCTURAL MEMBERS, MINIMUM 5/8" PLYWOOD OR CONCRETE. GYPSUM BOARD AND CEMENT BOARD ARE NOT A STRUCTURAL COMPONENT.

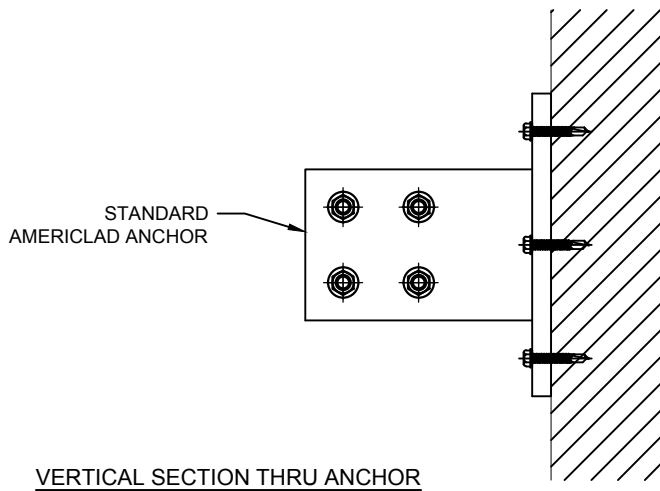
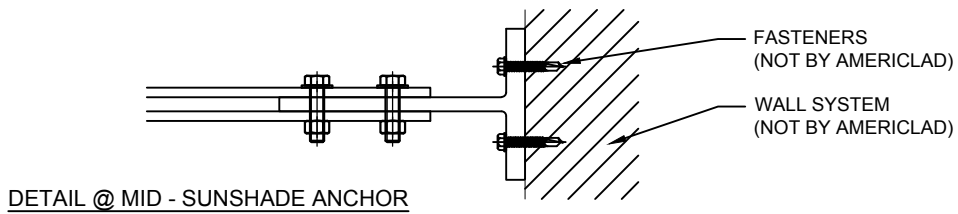
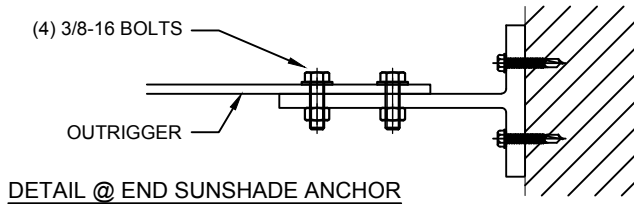

COPYRIGHT QUALITY METALCRAFTS, LLC

21925 Industrial Boulevard · Rogers, Minnesota · Toll-Free: 1-866-260-4047 · americlad.com

Architectural Metal Products



AC-110

ANCHOR (3)

DETAIL C

NOTE:

LOAD BEARING WALL COMPONENTS OF EITHER: 16GA STEEL STUDS, STRUCTURAL MEMBERS, MINIMUM 5/8" PLYWOOD OR CONCRETE. GYPSUM BOARD AND CEMENT BOARD ARE NOT A STRUCTURAL COMPONENT.

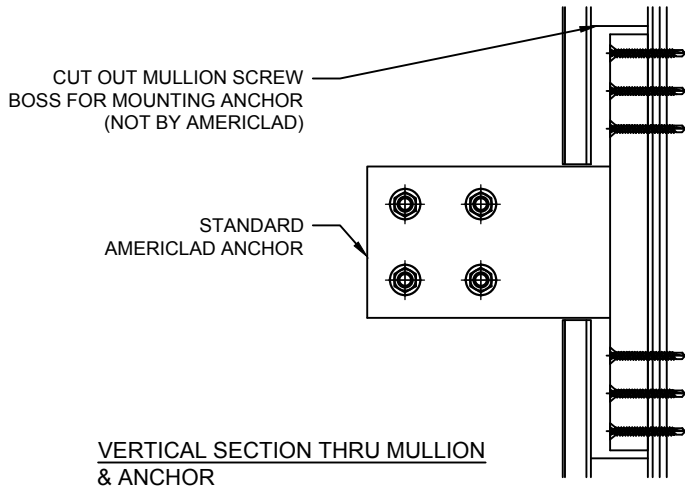
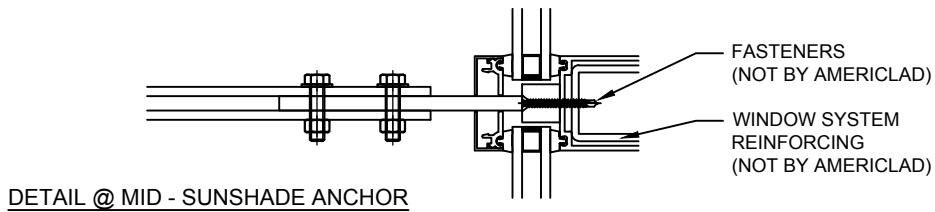
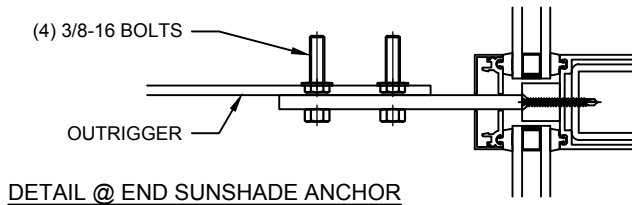

COPYRIGHT QUALITY METALCRAFTS, LLC

21925 Industrial Boulevard · Rogers, Minnesota · Toll-Free: 1-866-260-4047 · americlad.com

Architectural Metal Products



AC-110

SUNSHADE COMPONENTS

DETAIL D

NOTE:

LOAD BEARING WALL COMPONENTS OF EITHER: 16GA STEEL STUDS, STRUCTURAL MEMBERS, MINIMUM 5/8" PLYWOOD OR CONCRETE. GYPSUM BOARD AND CEMENT BOARD ARE NOT A STRUCTURAL COMPONENT.

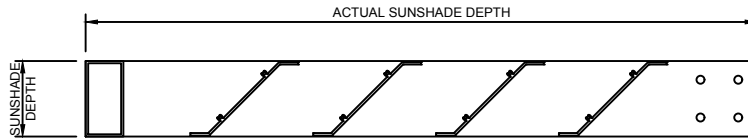

STANDARD AIRFOILS

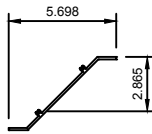
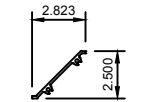

STANDARD FASCIAS

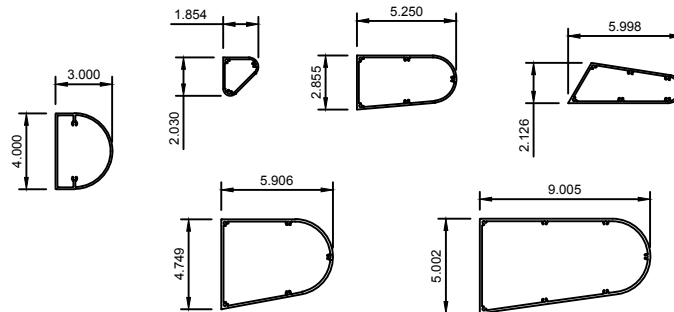
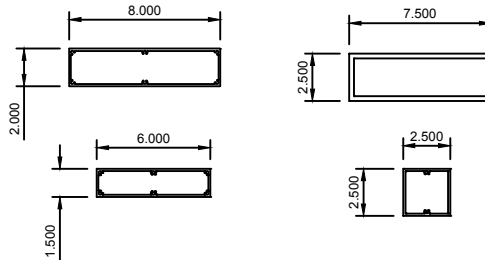
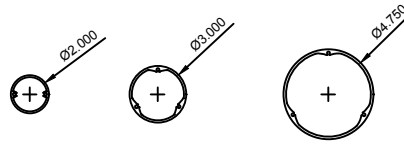

CUSTOM SIZES ARE ALSO AVAILABLE UPON REQUEST

COPYRIGHT QUALITY METALCRAFTS, LLC

21925 Industrial Boulevard · Rogers, Minnesota · Toll-Free: 1-866-260-4047 · americlad.com

Architectural Metal Products



AC-110

OUTRIGGER PROFILES

DETAIL E

NOTE:

LOAD BEARING WALL COMPONENTS OF EITHER: 16GA STEEL STUDS, STRUCTURAL MEMBERS, MINIMUM 5/8" PLYWOOD OR CONCRETE. GYPSUM BOARD AND CEMENT BOARD ARE NOT A STRUCTURAL COMPONENT.

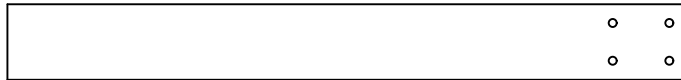

BOX OUTRIGGER

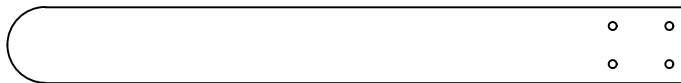

ROUND OUTRIGGER

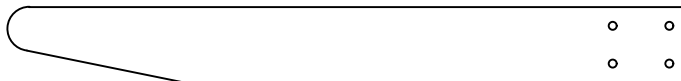

QUARTER ROUND OUTRIGGER

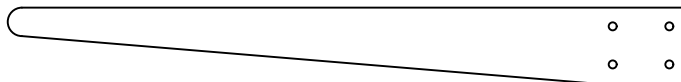

TAPER QUARTER ROUND OUTRIGGER

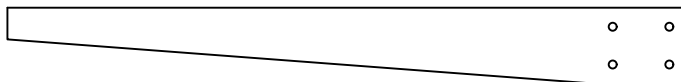

TAPER BOX OUTRIGGER

COPYRIGHT QUALITY METALCRAFTS, LLC

21925 Industrial Boulevard · Rogers, Minnesota · Toll-Free: 1-866-260-4047 · americlad.com

Architectural Metal Products