



AMERICLAD® AC-96SF  
www.americlad.com  
866-260-4047

MANUFACTURER:  
Quality Metalcrafts, LLC  
21925 Industrial Blvd.  
Rogers, MN 55374  
Telephone: (866) 260-4047  
Fax: (763) 255-3399  
Email: [info@americlad.com](mailto:info@americlad.com)

**AMERICLAD  
AC-96SF  
Louver**

**SECTION 08 90 00  
ALUMINUM LOUVER SYSTEM  
6" STATIONARY NON-DRAINABLE LOUVER WITH  
FLANGE FRAME**

**PART 1 – GENERAL**

**1.1 RELATED DOCUMENTS**

- A. The drawings and provisions of the General Conditions, and the sections included under Division 1 specification sections, apply to this section

**1.2 SUMMARY**

- A. This section includes aluminum louvers

**1.3 PERFORMANCE REQUIREMENTS**

- A. Performance Ratings: Product must be licensed to bear the AMCA Certified Ratings Seal for water and air performance
  - a. Based on testing 48 inches by 48 inches (1,219 mm x 1,219 mm) size unit in accordance with AMCA 500
- B. Free area: 9.17 square feet, 57%
- C. Water Penetration: Maximum 0.01 ounces per square foot of free area at an air flow of 916 feet per minute free area velocity when tested

**1.4 SUBMITTALS**

- A. Product Data: Manufacturer's product literature
- B. Finish Samples: submit color samples for final approval



- C. Shop Drawings: submit shop drawings showing plans, sections and details

### **1.5 QUALITY ASSURANCE**

- A. Manufacturer Qualifications: Minimum of five years experience in manufacturing of architectural products
- B. Installer Qualifications: Acceptable to manufacturer
- C. Production Qualifications: Louvers shall be licensed to bear AMCA Certified Ratings Seal Applies to air performance and water penetration ratings

### **1.6 DELIVERY, STORAGE AND HANDLING**

- A. Delivery: deliver louvers in manufacturer's crates packed for long haul transit
- B. Storage: store materials in a dry and safe area
- C. Handling: handle materials to avoid any damage to materials and finishes

### **1.7 WARRANTY**

- A. The contractor must warrant the materials to be free of defects in accordance with the general conditions. Finish warranty shall be extended by paint manufacturer's standard warranty
- B. Manufacturer shall provide a standard limited warranty for louver system for a period of one year from date of installation and no more than eighteen months after shipment from manufacturing plant

## **PART 2 – PRODUCTS**

### **2.1 MANUFACTURER**

- A. Quality Metalcrafts, LLC/AMERICLAD, 21925 Industrial Boulevard, Rogers, Minnesota 55374, Telephone: (866) 260-4047, [www.americlad.com](http://www.americlad.com)
- A. Approved equal submitted for approval 10 days prior to bid

### **2.2 FABRICATION**

- A. Model: AC-96SF Aluminum Louver System, 6" stationary, non-drainable louver with flange frame
- B. Performance Ratings: AMCA Licensed
- C. Frame:
  - a. Depth: 6" (101.6 mm)
  - b. Material: Extruded aluminum 6063-T5
  - c. Wall Thickness: 0.125 inch (3.175 mm), nominal



- d. Downspouts and caulking surfaces
- D. Blades:
  - a. Style: Stationary non-drainable
  - b. Material: Extruded aluminum 6063-T5
  - c. Wall Thickness: 0.125 inch (3.175 mm), nominal
  - d. Angle: 37.5 degrees
  - e. Centers 5.938 inches (150.83 mm), nominal

### 2.3 ACCESSORIES

- A. Aluminum Sill: Provide sill flashing manufactured from same material and finish as louvers where indicated on drawings
- B. Screens: provide framed removable screens for exterior louvers
  - a. Bird Screens
  - b. Insect Screens
  - c. Blank off Panels
    - i. Insulated
    - ii. Non-insulated

### 2.4 FINISHES

- A. Paint:
  - 1. Coating shall be a Spray Applied Fluorocarbon Resin Utilizing a 70% Kynar 500/Hylar 5000 resin
  - 2. Color as selected by owner from paint manufacturer's standard colors or Custom color as specified
  - 3. Material to be painted in accordance with either AAMA specification 2605 or 2604
- B. Anodized:
  - 1. Class I, Clear Anodic Finish: AA-M12C22A41, mechanical finish, nonspecular as fabricated. Coating to have an anodic coating of 0.7 mil (0.018 mm) thickness
  - 2. Class I, Color Anodic Finish: AA-M12C22A42/A44, mechanical finish, nonspecular as fabricated. Color to be determined by Owner. Coating to have an anodic coating of 0.7 mil (0.018) thickness

## PART 3 – EXECUTION

### 3.1 PREPARATION

- A. Coordinate drawings, diagrams, and instructions for installation

### 3.2 INSTALLATION



AMERICLAD® AC-96SF  
www.americlad.com  
866-260-4047

- A. Install louvers at locations as indicated on the drawings and in accordance with the manufacturer's instructions
- B. Install louvers plumb, level, in plane of wall, and in alignment with adjacent work
- C. Install joint sealants as specified in section 07 90 00

### **3.3 CLEANING AND PROTECTION**

- A. Clean exposed surfaces after installation per manufacturer's recommendation
- B. Touch up minor abrasions in finish with touch up paint supplied by finish applicator

**END OF SECTION**



21925 Industrial Blvd.  
 Rogers, MN 55374  
 866-260-4047  
 www.americlad.com

**AC-96SF STATIONARY LOUVER**  
 FLANGE FRAME

**STANDARD CONSTRUCTION**

**FRAME**

- 6" deep, 6063-T5 extruded aluminum with a .125" nominal wall thickness

**BLADES**

- 6063-T5 extruded aluminum with a .125" nominal wall thickness
- Blades are positioned at a 37.5° angle and spaced approximately 5.938" centers

**SCREEN**

- .5" x .051" thick, aluminum flattened expanded metal bird screen in a removable frame
- Screen will add approximately 0.5" to the overall louver depth

**FINISH**

- Mill Finish

**MINIMUM LOUVER SIZE**

- 12" wide x 12" high

**MAXIMUM LOUVER SIZE**

- 70 square feet per section
- Single section size not to exceed 120" wide x 84" high or 84" wide x 120" high
- Louvers exceeding the maximum single section size will be built in multiple sections and require field assembly

**BLADE BRACE SUPPORT ANGLES**

- Depending on louver size, wind load, or other special requirements, louvers will have rear mounted blade support angles that will increase overall louver depth

**Note: Louvers built .25" smaller than opening size given**

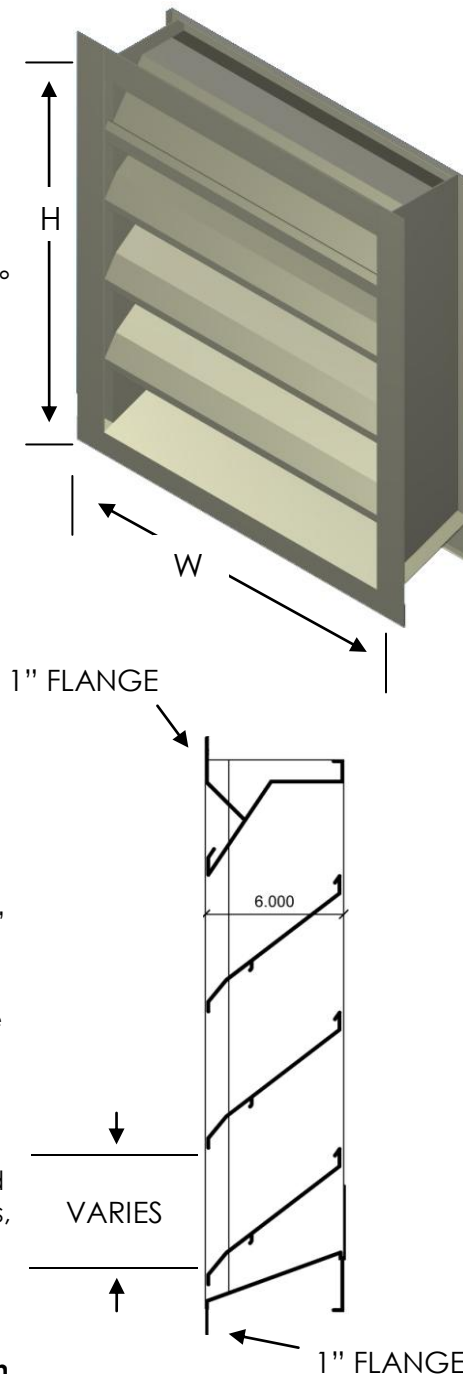

**STANDARD FEATURES**

- Aluminum construction, providing a high resistance to corrosion
- All welded construction for strength and durability
- 57% Free Area (based on a 48" x 48" unit)
- Drainable head collects and channels water to drainable jamb to provide excellent water penetration performance
- Hidden mullions allow for continuous blade appearance up to 120"
- Published performance ratings data based on testing in accordance with AMCA Publication 511

**OPTIONS AVAILABLE**

Many optional accessories to the basic design are available at an additional cost, including:

- Sill extension/head flashing
- Hinged frame/channel subframe
- Security bars
- Filter rack
- Bird/insect screens (please refer to screen submittal)
- Blank-off panels (standard or insulated)

**FINISHES**

- Kynar 500/Hylar 5000
- Baked Enamel
- Prime Coat
- Anodized in various colors and shades (some color variation is possible with anodized finishes)

**Contact Quality Metalcrafts, LLC / AMERICLAD® for any additional information or any special requirements**





AC-96SF

LOUVER - 6 INCH W/ FLANGE

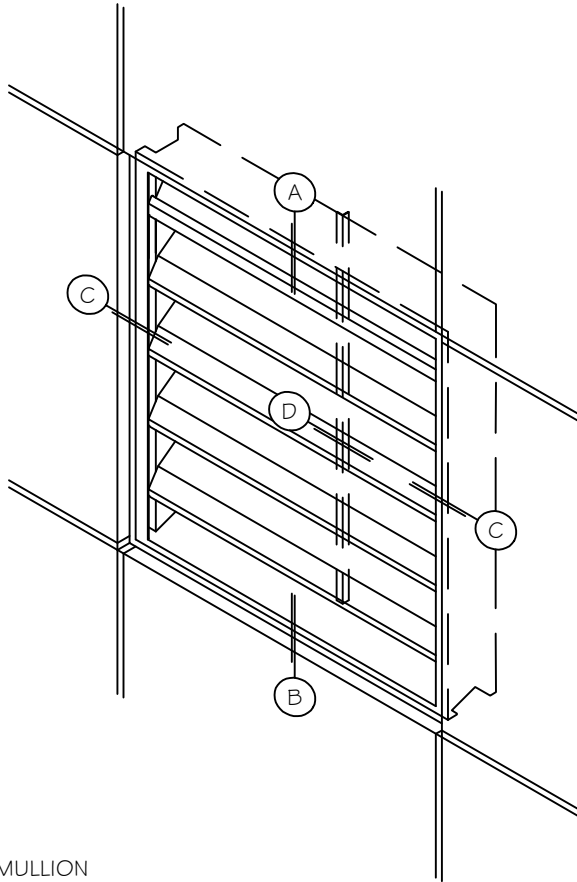

- (A) HEAD
- (B) SILL
- (C) JAMB
- (D) HIDDEN MULLION
- (E) SPECIAL SHAPE LOUVERS

COPYRIGHT QUALITY METALCRAFTS, LLC

21925 Industrial Boulevard · Rogers, Minnesota · Toll-Free: 1-866-260-4047 · [americlad.com](http://americlad.com)  
Architectural Metal Products



AC-96SF

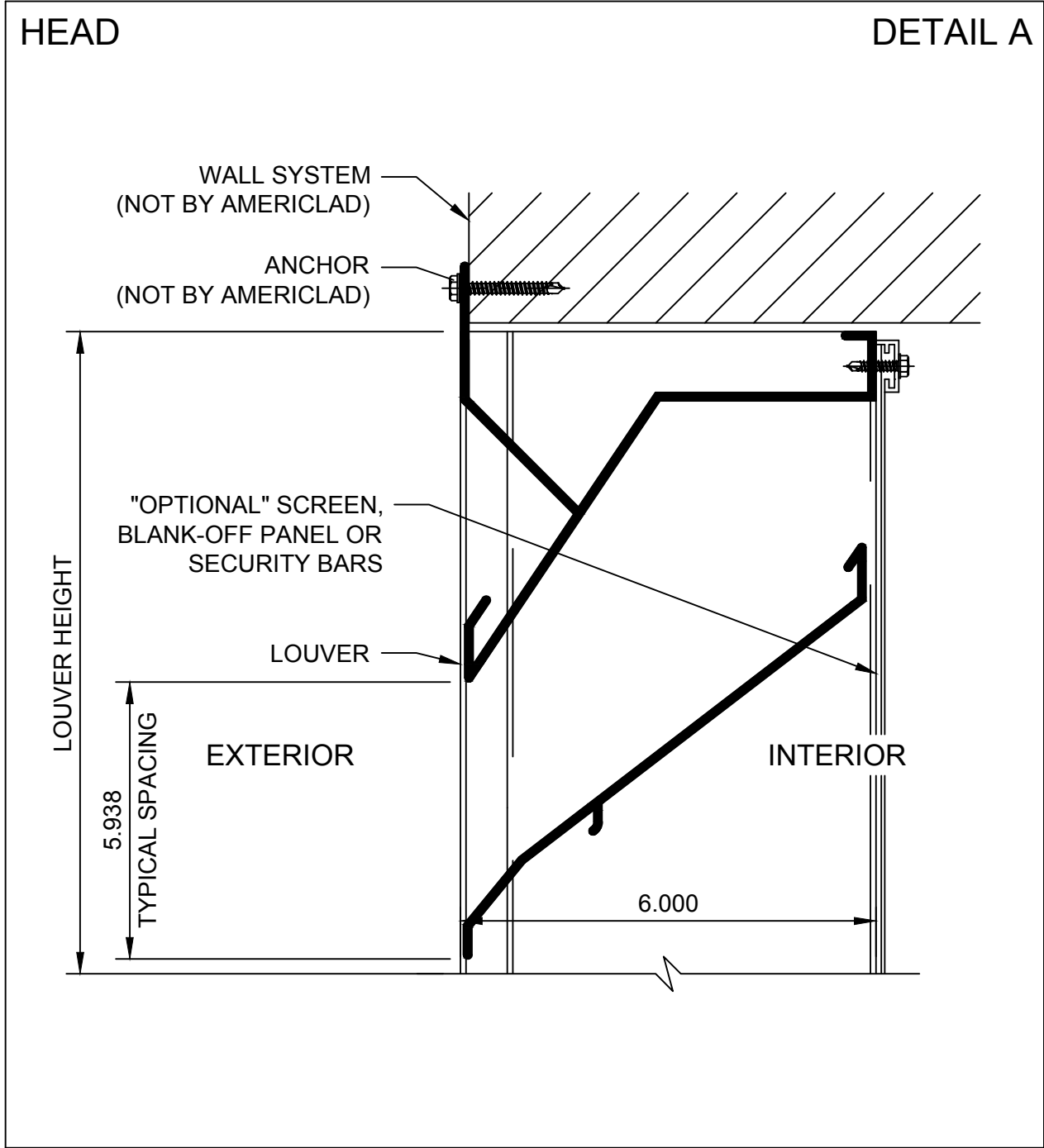

COPYRIGHT QUALITY METALCRAFTS, LLC

21925 Industrial Boulevard · Rogers, Minnesota · Toll-Free: 1-866-260-4047 · [americlad.com](http://americlad.com)  
Architectural Metal Products





AC-96SF

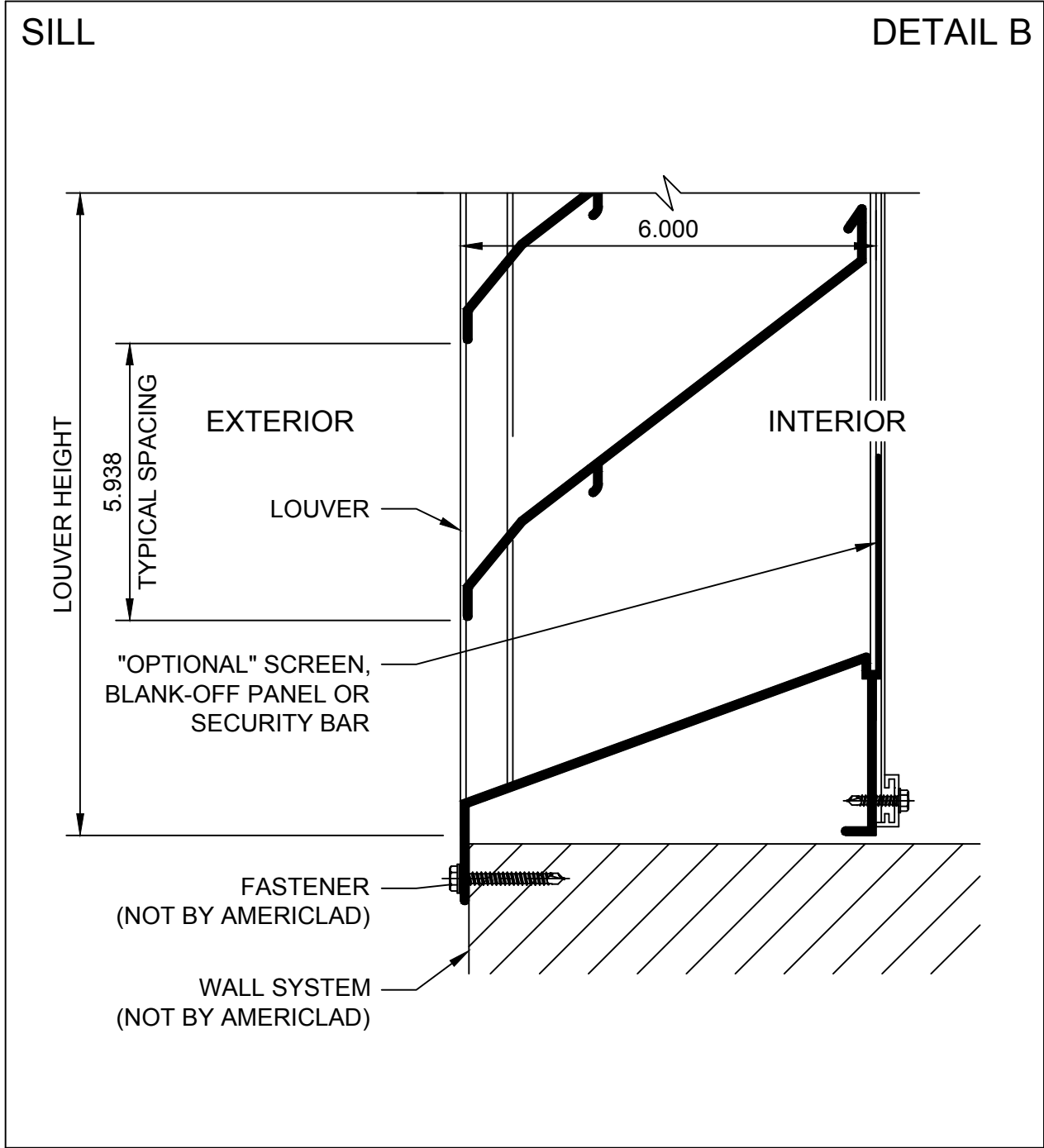

COPYRIGHT QUALITY METALCRAFTS, LLC



AC-96SF

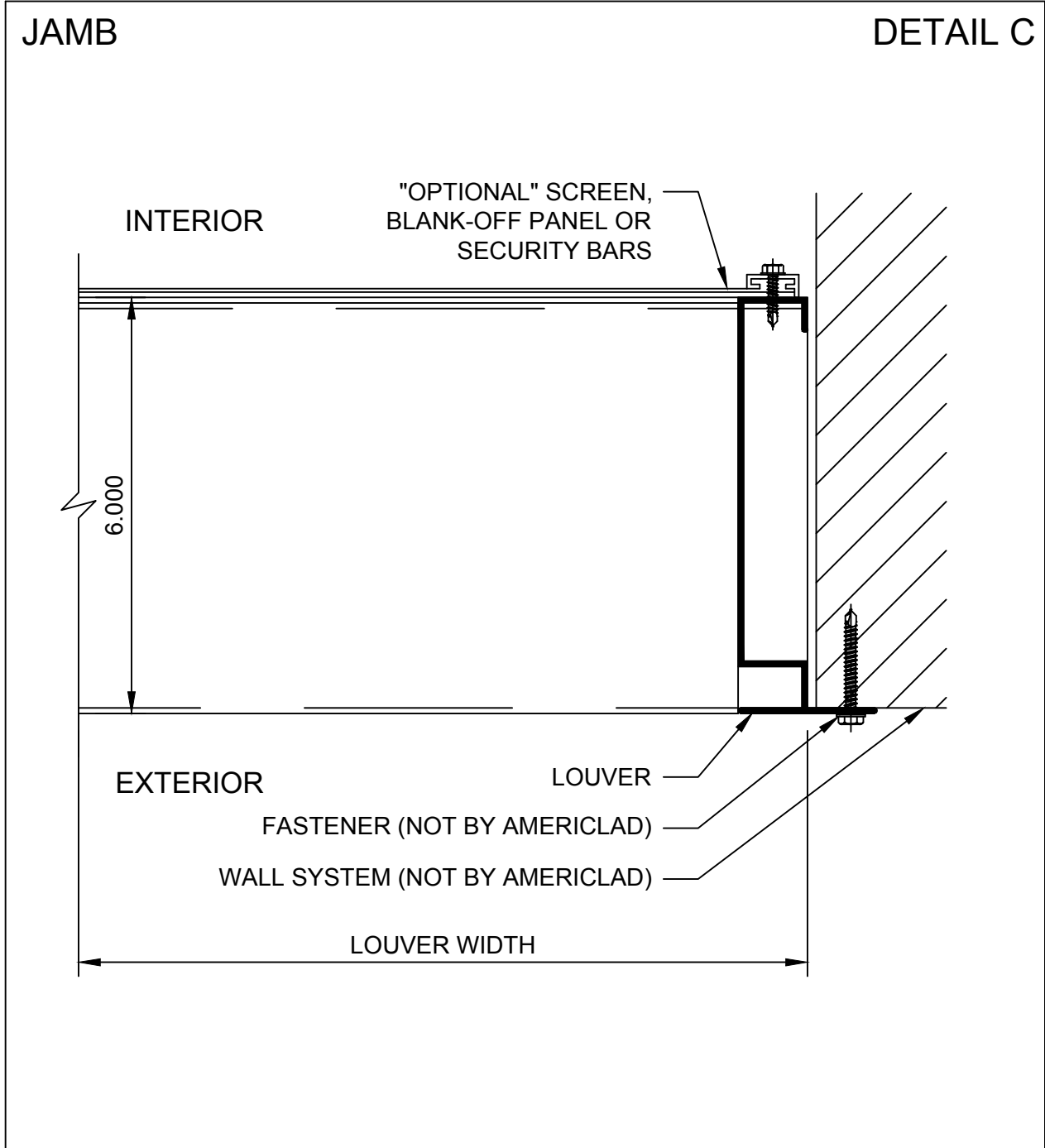

COPYRIGHT QUALITY METALCRAFTS, LLC



AC-96SF

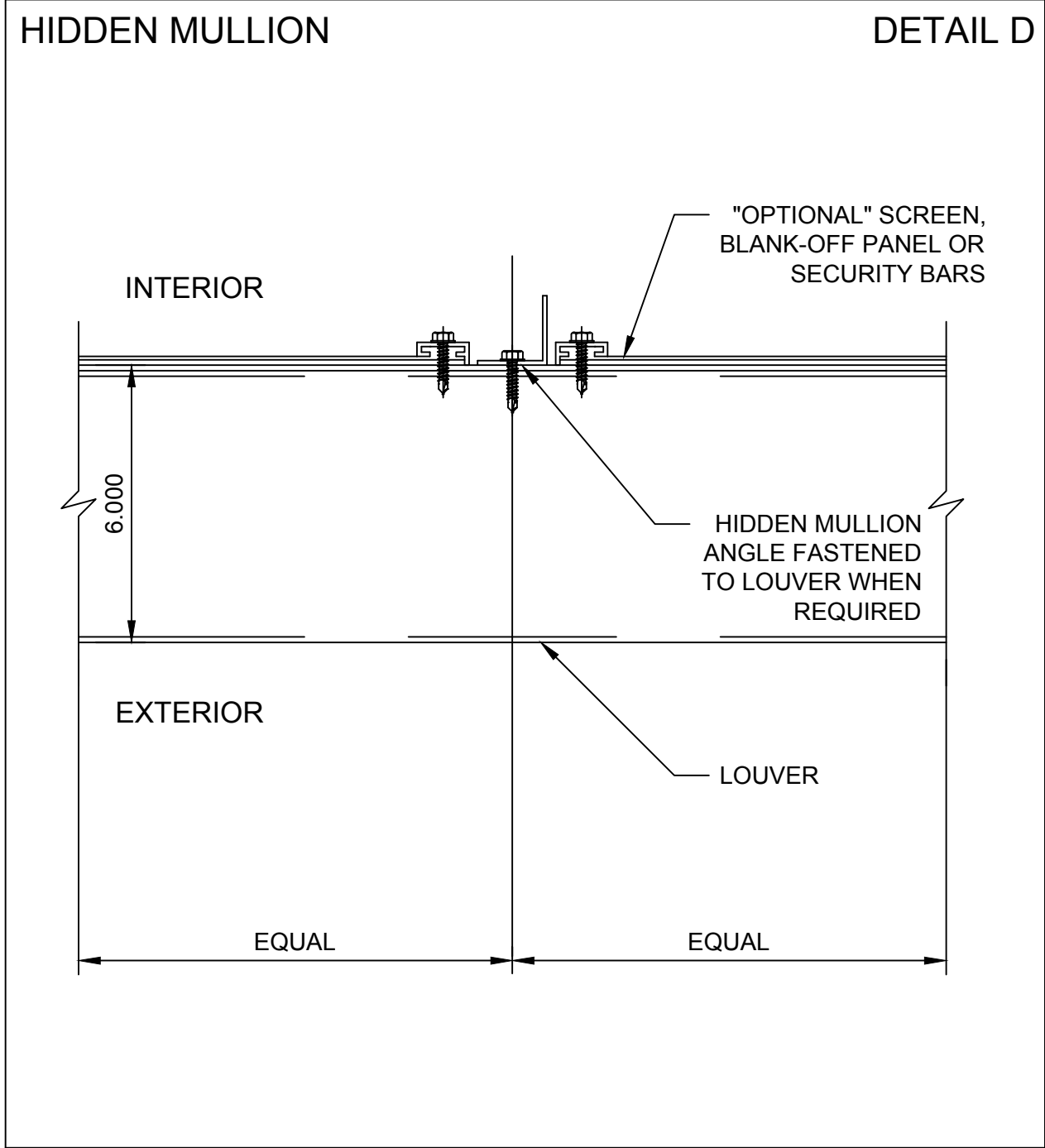

COPYRIGHT QUALITY METALCRAFTS, LLC

21925 Industrial Boulevard · Rogers, Minnesota · Toll-Free: 1-866-260-4047 · [americlad.com](http://americlad.com)  
Architectural Metal Products



AC-96SF

SPECIAL SHAPE LOUVERS

DETAIL E

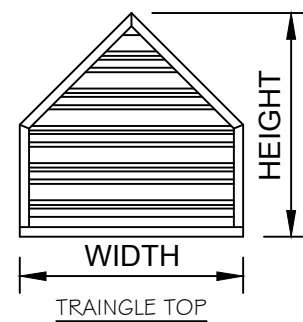
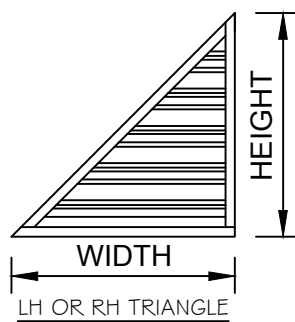
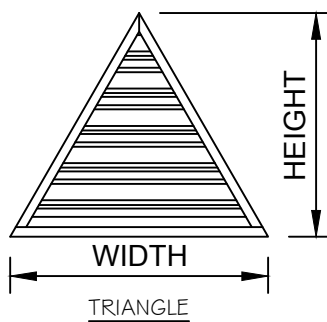
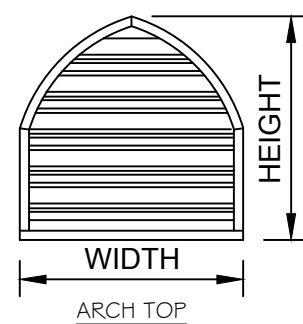
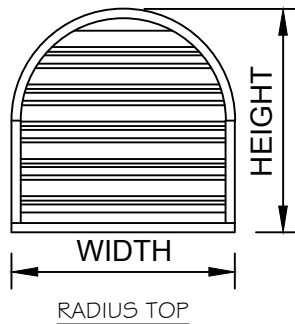
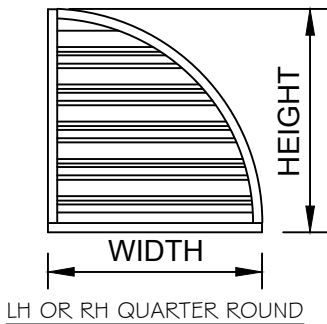
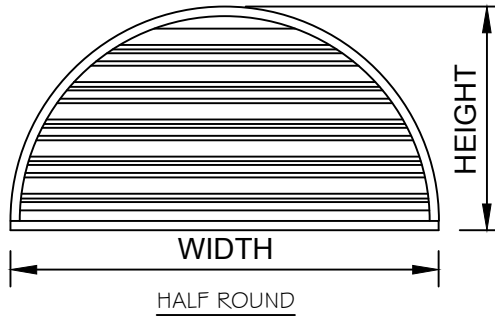
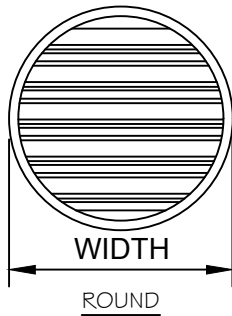

COPYRIGHT QUALITY METALCRAFTS, LLC

21925 Industrial Boulevard · Rogers, Minnesota · Toll-Free: 1-866-260-4047 · [americlad.com](http://americlad.com)

Architectural Metal Products